



Axis^{AX}

The Worldwide Fire System
ANSI/UL 864 9th Edition



The Standard in Fire Systems



Advanced is renowned for the quality, performance and ease-of-use of its products. Our Axis AX fire system is the professional choice in countries working to the UL standard worldwide.

We invest in design and engineering to bring best-in-class innovations to market every year, and our approach to customers, service and technical support is equally dedicated. All products in the Axis AX range are manufactured either in the USA or in the UK.

The Standard in Fire Systems



Contact your local office at: www.advancedco.com



Contents

The Standard in Fire Systems	4
The Worldwide Fire System	6
High Performance Panels	8
Integrated Audio and Firefighter Telephones	10
Command Centers	11
Intelligent Detectors and Loop Powered Intelligent Devices	12
Sample System Diagram	14
Advanced Networking	16
Dynamix Tools	17
DynamixSmoke	18
PerfectSync	19
Advanced360	20
Fire and Emergency Telephone System	21
A Global Leader	22



The Standard in Fire Systems



Advanced is known all over the world for making the best quality, best performing fire systems.

We design 'easy' into our products. We make it easy to set up a one panel system or a complicated 200 panel network. We make our software intuitive. We deliver fast, accessible support, training and service. Above all, we make it easy to rely on an Advanced system.

Fire Systems are in our DNA. Our people are among the most talented and experienced in the fire systems business. We train talented engineers and technicians every year. 25% of our business is dedicated to R&D. Our knowledge is unmatched, anywhere in the world and we're determined to keep it there.

Our systems are protecting people and property in over 60 countries world wide, in many of the most prestigious and challenging locations. We realize our growth comes from the strongest customer relationships. We stay friendly, flexible and reactive to your requirements and our customer service is consistently rated excellent.

We manufacture all of our panels in the UK to demanding quality standards and hold global approvals. We enjoy full ISO 9001 compliance across manufacturing and design.



- Manufacturing and Quality
- Admin
- Customer Service and Support
- R&D

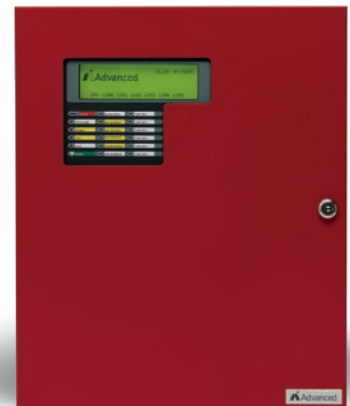

A Halma company



Welcome
to the
world of
Advanced

Axis^{AX} The Worldwide Fire System

The Professional Choice

Axis AX is our solution for customers demanding a high performance UL 864 based fire protection system.

Axis AX is built on years of leadership in the intelligent fire systems market. It is widely installed across the globe in some of the most challenging and prestigious locations.

Axis AX is a complete system of high performance fire panels, audio systems, command centers and high performance devices. At its core are intelligent single and multi-loop networkable fire alarm control panels with a complete range of intelligent SLC loop devices, extensive peripherals, NAC and conventional devices.

Axis AX is designed to go anywhere you need high quality, reliable and easy to use fire detection and control, from mass transportation and industrial complexes to landmark developments, historic buildings and public services.



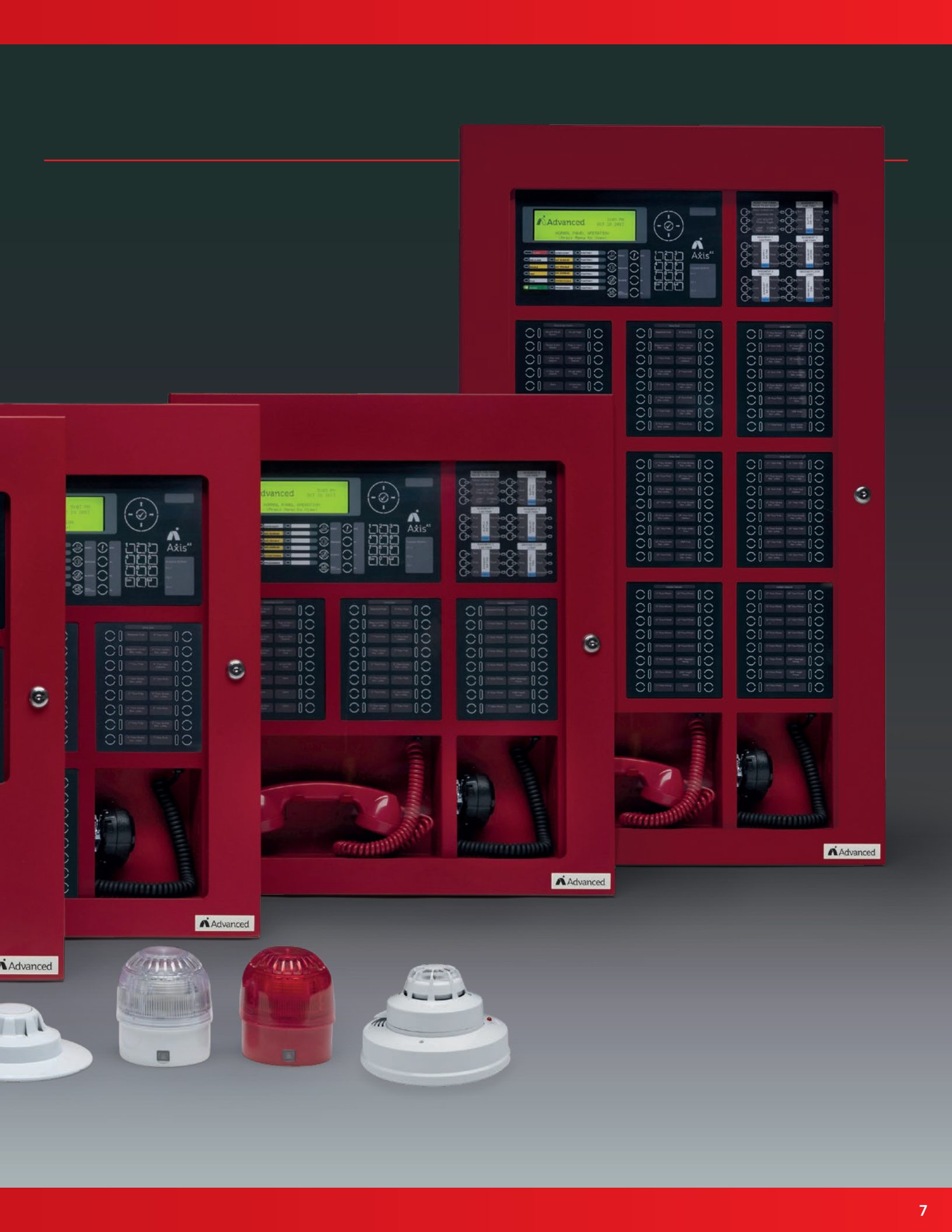

High Performance Panels

Axis AX control panels provide a unique scalable platform that can expand upwards or downwards to suit virtually any application.



Axis AX is the result of decades of fire alarm and detection experience gained from installations across the globe, involving architects, engineers, consultants, end users and fire authorities.

Axis AX panels have been designed to offer more power and performance in a user friendly format. Axis AX packs in more configuration, control and interface options than any comparable Advanced panel. Multiple advanced features mean it will maintain its performance advantages for years to come.

All of the intelligent fire alarm control panels in the AX series consist of identical electronic modules and can be programmed from a laptop PC configuration tool. Axis AX's features have been proven to sharply reduce installation time, help identify wiring and programming errors, provide local and remote system diagnostics as well as providing exceptional fire detection without nuisance alarms.

Every Axis AX panel features Advanced's unbeatable networking capabilities and Dynamix Tools fire panel software making it easy to use, configure and maintain, from the smallest to the largest of sites and with complicated cause and effect.

Our Axis AX panels are all manufactured at our state of the art facilities in the UK and meet demanding quality standards. All panels comply with ISO 9001:2015 and ISO 14001:2015, and our systems and procedures are continuously audited against the factory production control requirements demanded by our product approvals.

Features

- 1, 2 or 4 SLC loop formats
- Each 500mA digital signaling line circuit supports up to 126 intelligent devices
- 1,000 Fire Zones when networked or 200 per panel
- Easy, high performance networking (up to 200 nodes)
- Status monitoring from any panel or annunciator
- True peer to peer networking Style 4 or 7, wire or fiber
- Individual node configurable event reporting and control
- Comprehensive network diagnostics
- Compatible with all of the AX series peripherals including annunciators, relay modules, I/O modules, power supplies, internal and portable printers, network modules, LED/switch modules, conventional zone module, modem, RS232, amplifiers, DACTs and more
- SLC wiring can be shielded or non shielded
- Smoke detectors, CO detectors, sounder bases, open area sounders and beacons can be powered from SLC without need for a separate 24V supply
- Superb noise immunity and emissions
- Regulated loop voltage sustained during AC loss
- 2 or 4 voltage regulated NACs compatible with most listed NAC devices
- Two Amp current limit per NAC with alerts on panel or via email if limit exceeded
- Panel includes large 240x60 backlit LED with Advanced's simple navigation and programming
- Unique, built-in voltage and current meters for easy diagnostics can be viewed on panel or remotely
- Unique auto-test of battery cell integrity
- USB or RS232 interface for programming/panel monitoring
- Remote access and control via ipGateway or Virtual Panel tools
- 100% digital communications on the SLC to all intelligent smoke detectors and I/O modules
- Fast response and superior rejection of unwanted RF noise
- Multi-sensor programming options allow for supervisory pre-alarm upon programmable smoke obscuration, and fire alarm upon programmable temperature fixed or rate of rise
- Fully integrated 40/80 Watt digital audio options
- Advanced's simple select and click programming and configuration
- Autolearn and SLC loop detection
- Quick start and protect - a working system after an Autolearn is performed

Axis AX - 1 Loop



- 1 SLC loop - Class A (Style 6,7) or Class B (Style 4)
- 126 addressable intelligent points
- Available in compact and standard size enclosures
- 2 x 2 Amp Class A (Style Z) or Class B (Style Y) programmable NAC circuits
- 3 x on board relays. 1 Trouble, 2 programmable
- System keys for Reset, ACK, Silence, Resound & Drill
- 3 freely programmable system keys
- 19 on board LED indicators, 5 of which are freely programmable

Axis AX - 2 to 4 Loop



- 2 Loop Panel
 - 2 SLC loops - Class A (Style 6,7) or Class B (Style 4)
 - 252 intelligent addressable points
- 4 Loop Panel
 - 4 SLC loops - Class A (Style 6,7) or Class B (Style 4)
 - 504 intelligent addressable points
 - 2 x 2 Amp Class A (Style Z) or Class B (Style Y) programmable NAC circuits as standard, expandable to a total of 4 NAC circuits, 2 Amps each
 - 3 x on board relays. 1 Trouble, 2 programmable
 - System keys for Reset, ACK, Silence, Resound & Drill
 - 3 freely programmable system keys
 - 19 on board LED indicators, 5 of which are freely programmable
 - 5 to 10 Amp system power

Axis AX - Remote Annunciators



- Style 4 or Style 7 network interface
- C version has annunciation and programmable control
- D version annunciation only
- On board USB programming port
- Peer to peer, cross node operation
- Monitored external Trouble input
- Info displayed fully configurable to any combination of Fires, Troubles, Supervisory or other alarms
- Both models include programmable status LEDs
- Model ANN-C provides 3 freely programmable function keys
- Optional tamper proof and weather proof enclosures
- Surface or flush mount

Local Operating Console



- Axis AX network node
- Local annunciation, system and audio controls
- Add a local amplifier (optional)
- Ideal for MNS applications
- Remote microphone only option
- User Friendly Annunciation and Control, Identical to FACP
- Installation Configurable Operations and Controls
- Ad-Net-PluS Class A or B Network Compatible
- Supports up to 32 Peripheral Bus Modules
- Multi-Channel Audio Configurations

Axis AX - Peripherals



Axis AX panels can be customized with a large range of peripheral cards wired directly to the panel, or via the PENN, anywhere on the network:

- Integrated and/or networked audio options (see following pages)
- Conventional Zone Module (8 Class A or 4 Class A) - up to 16 modules per panel
- 4 or 8 Way high current relay modules
- Dual NAC Expander
- Style 4 & Style 7 network modules
- Fiber optic network converter module
- 48 Way I/O Switch/LED Driver
- Panel mounted printer
- 16 Way switch/48 LED module

Telephone Node



- When operating as independent network node:
 - Separate AC power and battery backup
 - Does not require Axis AX Fire Panel to operate
- When dependent network node:
 - Phones may be wired to any Axis AX panel or Telephone Node
- Can function as standalone emergency telephone system
- LCD annunciation of telephone events
- Ack, Hold, Scroll 'paging patch' control buttons



Integrated Audio and Firefighter Telephones

Axis AX comes ready for complete audio configuration. With the addition of an Advanced audio module (AV-AMP-80), any Axis AX control panel or Command Center becomes fully audio capable.

A variety of fire fighter telephones and telephone accessories are compatible with all Axis AX Command Center panels. Addressable telephones make control, supervision and identification superior to older technological solutions. Command Centers come with easy to operate LED or LCD "telephone switchboard" monitoring and control displays.



Audio Node

- Easy and fast configuration with Dynamix Tools audio configuration wizard
- Designed to operate as a node on the Axis AX network
- Provides increased digital audio signaling during an emergency situation
- Each amplifier has two independent 40W, 25Vrms outputs
- Each amplifier contains an independent 16 channel digital message/tone generator
- Unique amplifier booster/cascading option
- Superb sound quality
- Simple programming via USB
- Two (2) Class "A" or "B" speaker circuits
- External AC Power and Trouble LEDs
- Internal service diagnostic and status indicators
- Each amplifier may be programed for 1 to 1 backup
- Powerful CBE logic programming
- All amplifier audio output signals are synchronized across the AX network

Telephone Node

- When operating as independent network node:
 - Separate AC power and battery backup
 - Does not require Axis AX Fire Panel to operate
- When dependent network node:
 - Phones may be wired to any Axis AX panel or Telephone Node
- Can function as standalone emergency telephone system
- LCD annunciation of telephone events
- Ack, Hold, Scroll 'paging patch' control buttons
- Image on page 9



Audio Panel

- Fully featured Axis AX Audio panel
- Built-in live voice paging microphone
- Manual message activate switches
- Two (2) Class "A" or "B" speaker circuits
- AC power on, amplifier and PSU and Trouble LEDs
- Internal service diagnostic and status indicators
- USB interface for message/tone programming
- Optional one-to-one amplifier backup capability
- Three prioritized relay trigger inputs



Fire Fighter/Warden Page Telephone

- Each master supports up to four secondary telephones and/or jacks
- Standard or push-to-talk handset
- Magnetic, keylock or glass break door options
- Standard or coil cord phone cable
- Background noise cancellation module (option)
- Integrated 'dial', 'ring', 'busy' and 'hold' tones with 'connected' LED indication

Zone Splitter

- Fits Axis AX Command Center or Audio Panel
- Used with Audio Module
- 2 input/output options
- 1 input split into 4 outputs (total 40W)
- 2 inputs split in 2x2 outputs (total 80W)



Command Center Firefighter Phone

- Compatible with Axis AX Command Centers
- Standard or push-to-talk handset
- Class A or B Riser
- Background noise cancellation module (optional)
- Easy installation
- Supports up to 500 field phones

Telephone Riser Module

- Each riser supports up to 250 master phones, (two risers max)
- Live analog audio, no digitization
- Up to 5 telephones per riser may be active simultaneously
- Easy to configure with Dynamix Tools telephone wizard
- May be located remotely in separate enclosure or integrated into Command Center enclosure
- Supports Fire Warden remote paging feature
- Class A or B

All-Call Remote Microphone

- Lockable enclosure with microphone
- Completely supervised with interfaced audio amplifier
- Microphone supervised for opens and disconnection
- Advanced CAT30 key access
- Removable inner and outer doors for servicing
- Visible power and trouble LEDs
- PCB service/diagnostic status LEDs
- Plexiglas window
- Surface or semi flush mountable



Addressable Telephone Jack

- Individually addressable telephone jacks
- Phone active LED indicator
- Telephone riser supervision
- Supervises against opens, shorts and grounds
- Class A or B configuration
- Mounts to single gang electrical box
- Field programmable buzzer and LED indicators
- Five phone 'party line' communications
- Slide in label



Portable Fire Fighter Phone Handset

- Used with any Axis AX Addressable Telephone Jack
- Tip and sleeve connection
- Built-in noise filter
- Standard or push-to-talk
- Background noise cancellation module (optional)

70 Volt Converter Module

- Compatible with Axis AX Audio Booster, Audio Panel, Integrated Audio panels and Command Centers
- Converts single or dual 25 Vrms audio output to 70 Vrms audio signal
- All wiring is fully supervised
- Ideal for retrofit applications

Command Centers

Axis AX Command Centers are built on the backbone of our Axis intelligent fire panels to support a wide variety of configurations and applications.

All command centers are supplied in modular format for easy expansion and customization. Our smaller command centers can be ordered as fully configured. All of our Command Centers are fully compatible with Axis AX audio and telephone options. The Advanced Telephone Riser Module can be mounted inside the Command Center or remotely within a separate Telephone Node for added security.

Axis AX Command Centers



- Order fully factory configured or in modular format for configuration on installation
- 1, 2 or 4 Loops
- 126, 252 or 504 addressable points

2 Cabinet Sizes

- 2 cabinet sizes (3x3 and 3x5)

Network Nodes and Accessories:

- Digital Communicator – Cellular, Ethernet and POTs DACTs
- IP Gateway – only one required for 200 node network
- AX-BMS Module – provides interface to Building Automation System
- Ad-View Graphics
- AX-DGP – data gathering panel
- AX-LOCs – Local Operating Consoles
- Smoke Control Panel
- Graphic Annunciator(s)
- AX-VB Distributed Audio Panels
- Telephone Node
- Fiber Converters

Features

- PerfectSync synchronization of audio and strobes across entire 200 node network
- Dynamix Smoke dedicated/non-dedicated smoke control
- 520Hz audio support
- Failsafe operation if loss of master Command Center
- Supports multiple “true peer to peer” Command Center operations
- Intuitive and easy for fire fighters to operate
- Supports “request/control/deny” command center operation
- Audio confirmation LEDs indicate when speaker zones are active
- All Call, Page Evacuate, Page Alert & Page Inactive and Selective Paging features
- Manual activation of any message to any zone or group of zones
- No performance degradation as the number of network nodes expands
- Dynamix Smoke smoke control
- Mass Notification and non fire “Warning” Options
- Integrated telephone annunciation (LED or LCD) and controls
- Dynamix Tools wizard provides default telephone and audio options making set-up easy and fast
- Powerful control-by-event programming with intelligent system test facilities provides superior system diagnostic and test functions
- Built-in network, AC power, aux power, battery and field wiring diagnostics
- Color coded slide in labels with large text to identify system functions
- Fire warden page
- PAS, 2-Stage, Alarm Verification and Event Mode
- Zone and Point Disable/Enable
- 1,000 system zones



PerfectSync

DynamixSm*ke

Intelligent Detectors and Loop Powered Intelligent Devices

All Advanced Intelligent Detectors and Loop Powered Devices come with a 10 year warranty.

- Built in automatic drift compensation that will maintain the detector's sensitivity at a constant level even with severe chamber contamination.
- Drift compensation values are stored in the head, not the fire panel, and remain there even if power is removed from the head.
- 5 programmable sensitivity settings.
- Built in periodic test facility that meets NFPA requirements.
- Programmable maintenance alert and dirty detector warning
- All PCBs conformal coated to protect against corrosion
- Patented XPerT address setting in the base protects against common errors that occur during servicing. Insures match between the base and type of detector as well as correct sensitivity setting.
- Superior false alarm immunity
- Dual red LEDs, with 360 degree view, indicate polling and alarm activation.
- High speed digital communications provide rejection of common ambient RF noise
- Low profile
- Resilient plastic (94 V0) that will not discolor over time

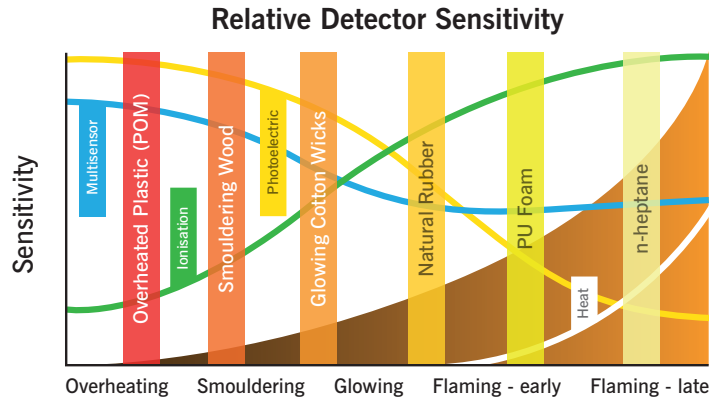

Sensors & Bases



Photoelectric Smoke Detector

- Incorporates an IR (infrared) LED and photo diode
- Ideal for slow burning or smouldering fires (particles >.3 microns)
- Ten 7-day response sensitivity mode timers
- Sub-addressing of ancillary functions



MultiSensor (Smoke & Heat)

- Incorporates both an IR sensor and thermal sensor
- Ideal as a general purpose sensor that responds well to a wide range of smoke/fire types
- Independent signals from each sensor
- Signals processed according to the response/sensitivity mode selected
- Ideal for giving supervisory warning for low levels of smoke detectors and full fire alarm due to rate of rise in temperature
- Ten 7-day response sensitivity mode timers
- Sub-addressing of ancillary functions



Heat Detector

- Incorporates a single open air thermistor bead
- 135° to 200°F static/rate of rise sensor
- Ten 7-day response sensitivity mode timers
- Sub-addressing of ancillary functions



EZ Fit Detector Base

- Compatible with 4" square or octagonal electrical boxes
- Fast and Easy to install
- Supports Patented XPerT addressing
- Device address setting readily visible once installed
- In-Out and LED output terminals support 14 gauge solid wire
- Dedicated terminal for shielded cable



CO Detectors

- Combination CO detector and sounder base
- Supports Photo, Multi and Heat detectors
- Temporal 3 for smoke alarm, temporal 4 for CO alarm (85dB)
- Integral test button
- Easily replaceable CO sensor module
- Sync module available or sync off panel NAC circuit
- Detects 3 levels of carbon monoxide: 70, 150 and 400 parts per million
- CO sensor module has 6-year life
- Sounder base is available as either 3 Khz output or as low frequency 520 Hz output
- Optional blank covers available for standalone CO detection



Sounder Beacon Base

- 15 tone and 7 volume settings
- Available with red or amber beacon
- Built-in synchronisation (audible and flash)
- Integral self-test features
- Individual or group addressing
- Beacon flash rate of once per second
- "One-way-only" detector insertion
- Base to detector locking mechanism
- Drastically reduces installation costs
- Programmable volume settings
- Highly visible alarm status indicator
- Enhanced option has 15 tone and 7 volume settings



Loop Isolator & Isolating Detector Base

- Short-circuit isolation
- Meets NFPA Style 7 requirements
- In-out terminals for ease of wiring
- Dedicated terminal for shielded cable
- Built-in short circuit yellow LED Indicator
- 3" or 4" square or octagonal electrical box mount
- "One-way-only" detector insertion
- Base to detector locking mechanism

Beacons & Sounders



Beacon

- Available in red, amber or clear
- Lens uses high intensity LED
- Available in outdoor configuration
- 1 Hz flash rate
- Built-in synchronization
- Integral self-check feature
- Wide angle of visibility
- Beacon flash rate of once per second
- "One-way-only" detector insertion
- Base to detector locking mechanism



Open Area Sounder/ Beacon

- Steady or temporal signaling
- Available in red or white
- Available in outdoor configuration
- Drastically reduces installation costs
- Programmable volume settings
- Built-in device isolation wiring
- Separate sounder base with drillable knockouts
- Two programmable tones and volume settings
- Continuous 2900 Hz tone
Vols: Low 70.6 dB, High 79.1 dB
- ANSI temporal 2900 Hz tone
Vols: Low 67.8 dB, High 75.3 dB
- Synchronization of Alert and Evacuation tones
- Individual and group addressing
- Unique integral self-test
- Security locking tab

Pull Stations



Manual Single/Dual Action Pull Station

- Single or dual action
- Low profile, high visibility design
- Visual indication of activation including red status LED
- Integrated Form C relay contact
- Surface or semi-flush mountable
- Available in special application colors
- key-lock for reset
- Die-cast metal construction



Dual Action Polycarbonate Pull Station

- Low profile, high visibility design
- Visual indication of activation including red status LED
- Internal access without alarm activation
- Lock reset
- Surface or semi-flush mountable
- Captive screw terminals

Intelligent Modules



Switch Monitor Modules

- Class A (Style D) or Class B (Style B) wiring
- Flexible device type programming
- Optional priority interrupt
- 8 position addressable DIP switch
- Integral status LED
- 4" or 2-gang electrical box mounting
- Following options available:
 - Isolator Module
 - Mini Switch Monitor Module
 - Mini Priority Switch Monitor Module
 - Priority Switch Monitor Module
 - Dual Priority Switch
 - Monitor Module



Input/Output Module

- Supervised initiating device circuit (IDC)
- Class A (Style D) or Class B (Style B) wiring
- Independently controlled Form-C relay contact
- Dynamix I/O relationship programming
- IDC activation status LED
- Optically isolated voltage input
- SLC powered and sub-addressable
- 4" or 2" electrical box mounting



120V Output Module

- Supervised initiating device
- Class A (Style D) or Class B (Style B) wiring
- Independently controlled 120VAC/30VDC relay contact
- Dynamic I/O relationship programming
- IDC activation status LED



Dual Priority Switch Monitor

- 2x Supervised initiating circuits (IDC)
- Dedicated IDC activation status LEDs
- Class A (Style D) or Class B (Style B) wiring
- 4" or 2" electrical box mounting



NAC/Sounder Control Module

- Class A (Style Z) or Class B (Style Y) wiring
- Horn/strobe or speaker control
- Flexible programmability
- 4" Square or 2-gang electrical outlet box mounting
- Power limited
- Dedicated NAC status LED
- Voltage Regulated NACs (compatible with all listed NAC devices) - Use with regulated 24 VDC power supply
- 25/70 VRMS speaker capability



Relay Output Module

- Two isolated Form "C" relay contacts
- Single poll volt-free changeover
- Flexible device type programming
- Loop Powered Directly from SLC Loop
- 7 position addressable DIP switch
- Integral status LED
- 4" or 2-gang electrical box mounting
- Durable construction

Axis^{AX} Sample System Diagram

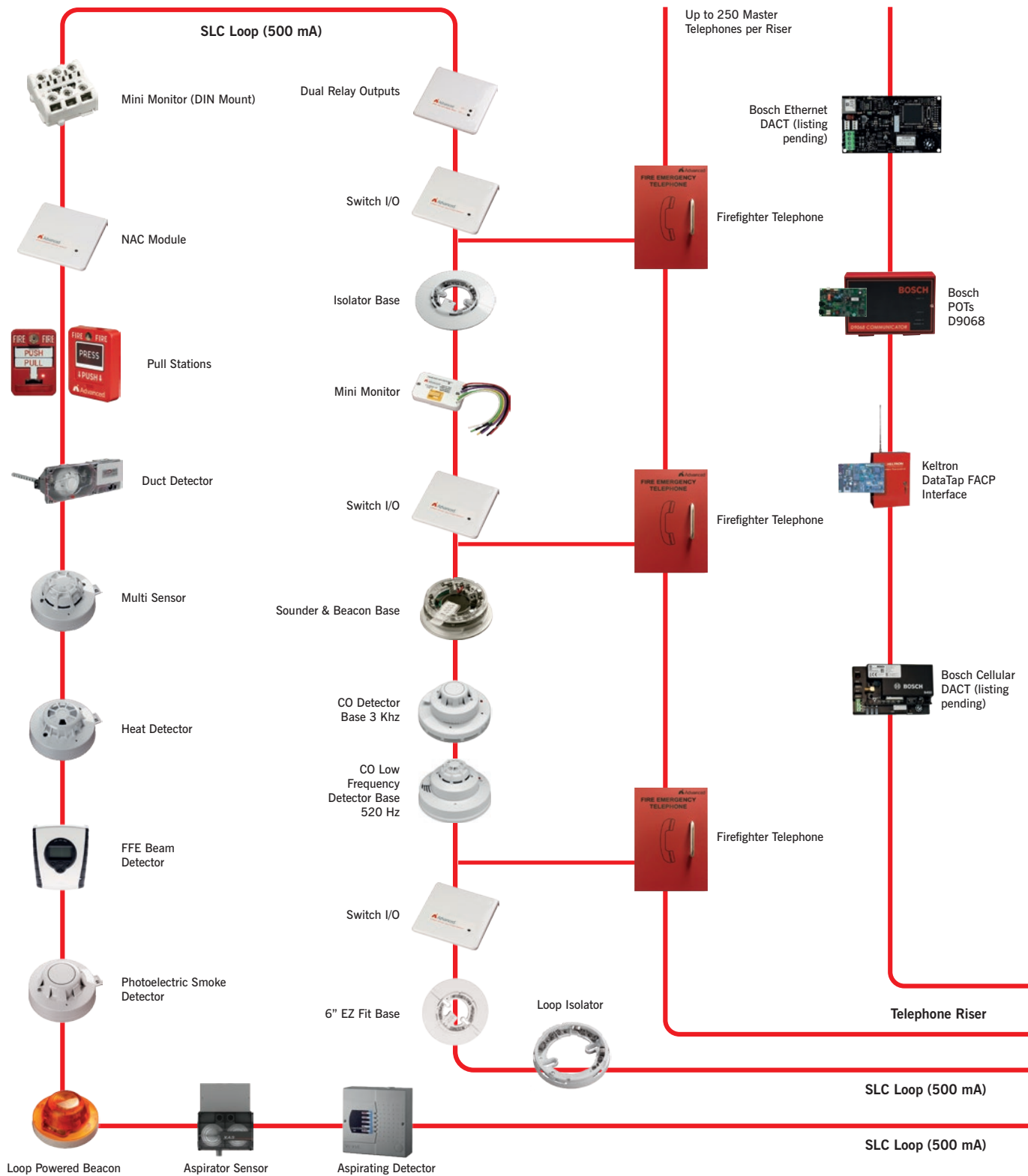

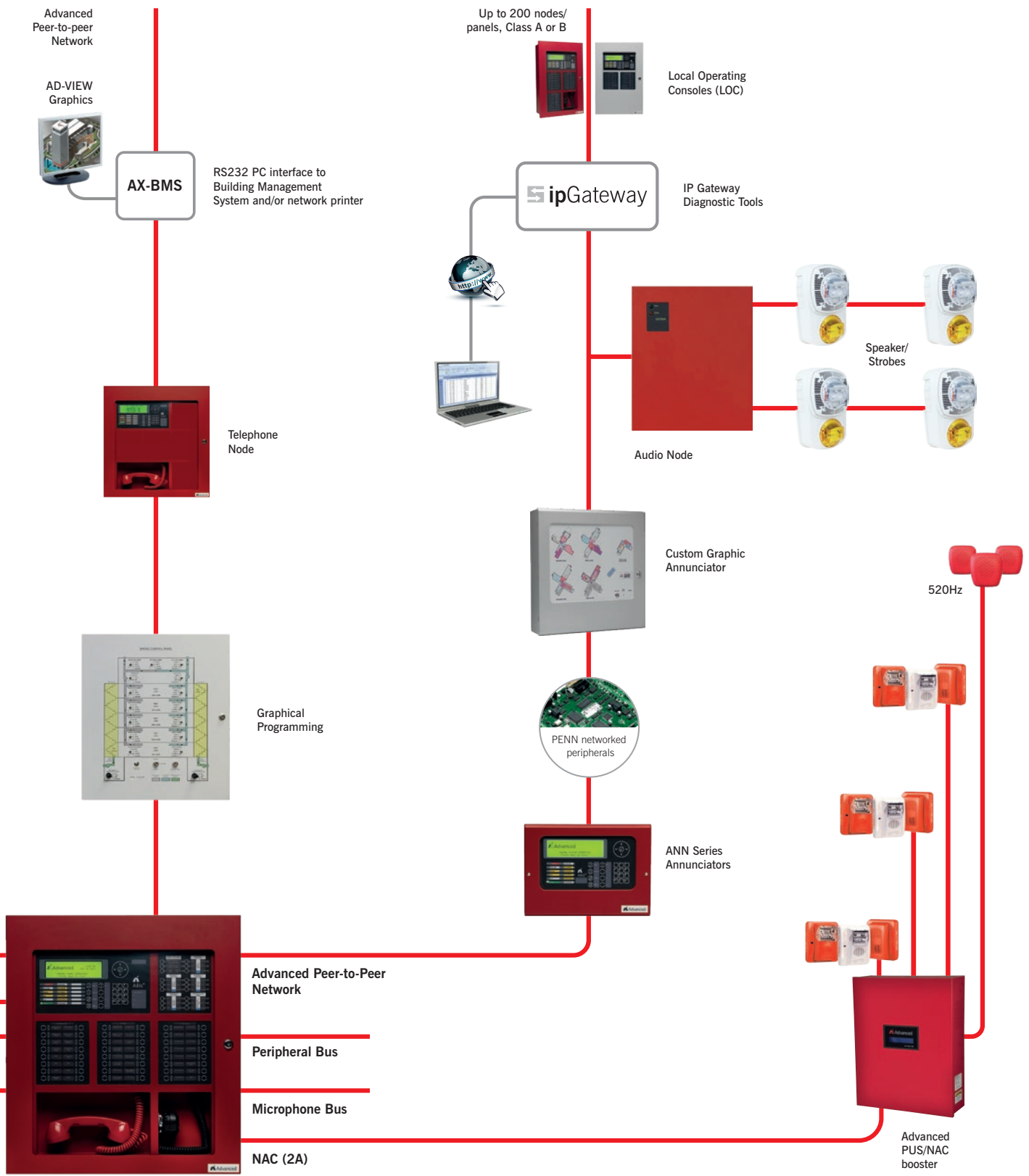

Advanced Networking

Advanced delivers fast, reliable, peer to peer communications from the smallest two panel network up to a large 200 node network.

Advanced network systems are fully scalable to suit virtually any application including “campus” style and “high rise” style configurations. Built-in diagnostics and test facilities make installation and ongoing maintenance simple. Performance in excess of multiple international standards.

- Peer to Peer performance for optimum distributed intelligence
- Consistent system performance independent of the number of nodes
- Synchronization of audio and strobes across entire 200 node network
- Fail Safe operation if loss of master Command Center
- Supports multiple true peer-to-peer Command Center operations
- Request/control/deny
- Sectoring feature allows customized operations per node
- Integrated or Isolated high rise telephone network option
- Single or multiple DACT, radio and/or City Tie options
- Offline test option isolates panels from network during testing without fear of false alarms
- Class B cable wiring - 32 Nodes, 5,000ft maximum
- Class A cable wiring - 200 Nodes, 5,000ft between nodes, 66,000ft maximum
- Fiber cable - 16,404ft max between nodes
- ipGateway transmits emails and text messages via a secure internet connection while also allowing viewing of system status and controls capability remotely
- AdView Graphics provides graphical user interface in single or multiple stations
- AX-BMS interfaces to 3rd party Building Automation and Controls solutions via standard BACnet or Modbus communications
- One configuration tool is required to program Axis AX panels. Diagnostic features prevent erroneous actions that may be detected prior to on site installation and test
- Each intelligent audio node contains up to 16 digital messages which are synchronized across the entire 200 node network
- Loop power technology built into each panel provides tremendous application options
- Nodes may be customized to suit any application, reducing installation costs and maximizing performance. Nodes may (or may not) include SLC loops, displays, microphones, telephones, amplifiers, power supplies, switch modules, and any AX peripheral device

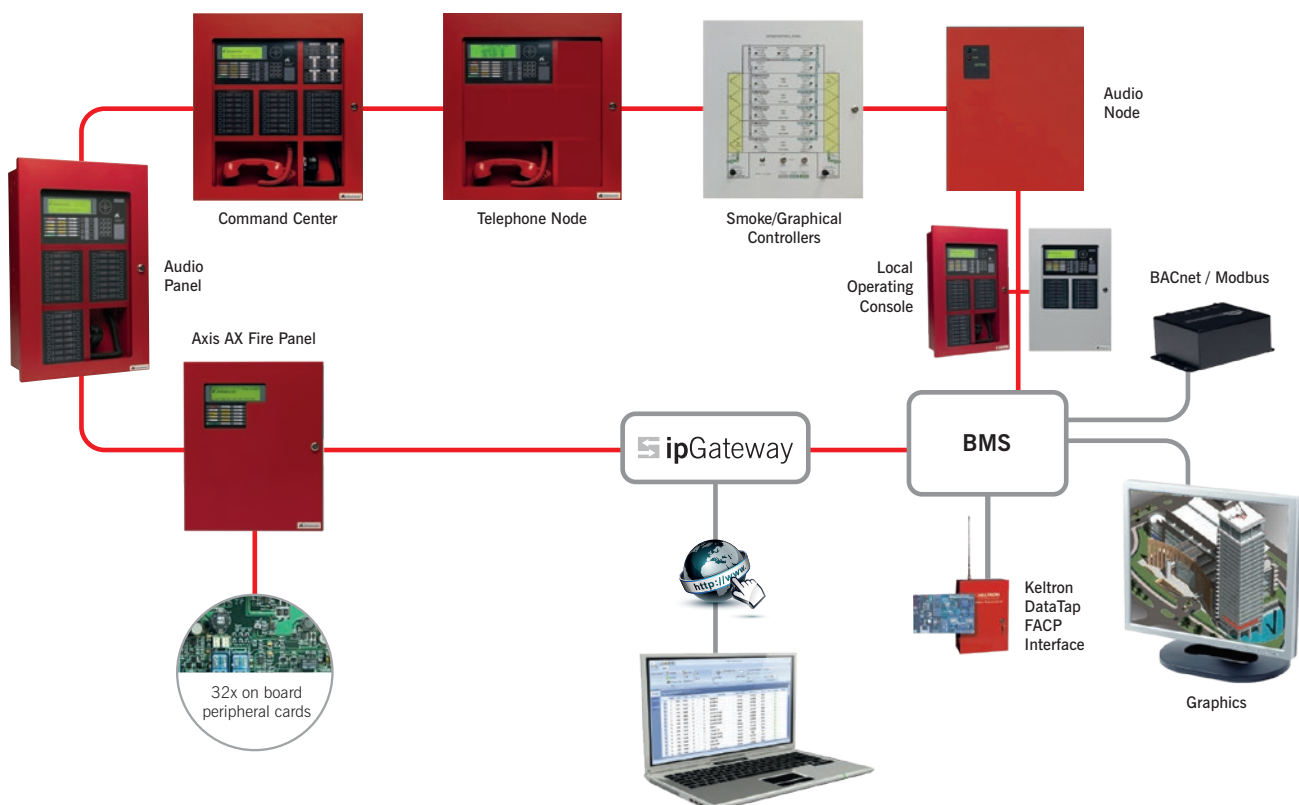

DynamixTools

Dynamix Tools are a suite of Axis AX software based tools that are easy to operate, easy to understand and make the complicated simple.

Dynamix Tools are developed with the primary goal of providing the highest levels of value to our customers and end users - before, during and after installation and commissioning.

Dynamix Tools are enhanced on a continual basis, adding new features and performance characteristics. The most recent well received enhancements included introduction of our industry unique Service Tool which provides superior support for lifetime system performance, including false alarm prevention and service records.

Dynamix Tools keep pace with fast changing and challenging advancements in PC technology.

Config Tool

- Single Tool required for programming entire Axis AX range of panels
- Full configuration of single panel or network system
- Automatic design check of site configuration
- Assistants menu helps the engineer to easily configure panels
- Import, export information and print configuration reports
- All panels come with compatible built in USB and RS232 ports

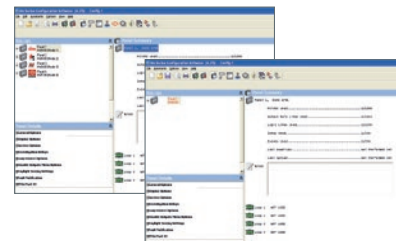

Service Tool

- Primary use is to support lifetime system maintenance and performance
- Insure annual testing of system meets national and local requirements
- Identify drift compensation levels of all detectors
- Rapidly identify which detectors have or have not been cleaned and tested
- Per SLC device, determine when installed, last activation, last tested, last enabled or disabled and date installed
- Use tool live as a network simulator to diagnose and test system performance without need to connect fire panels or trigger false alarms
- Create unique customized reports for Service Company, End User, Facility Managers and Fire Department

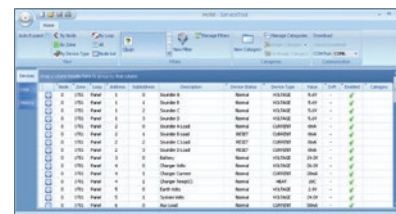

Terminal Tool

- Primary use is to operate and test panel from remote location
- Image is identical to remote panel and operates in "real time"
- Direct USB or RS232 or remote IP connection options
- Real time status and control
- Allows download of history files



Logo Tool

- Allows customization of the panel's LCD during normal operation including distributor's name and logo, or the site's identification
- Uploads standard bitmap images
- Tool allows creation of logos
- JPG and GIF images can be imported

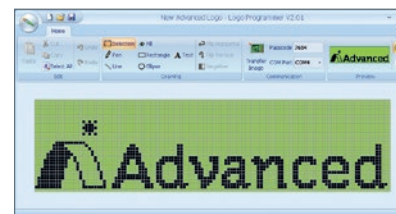

Approved to:
UL864 standards – complies
with UUKL requirements.

DynamixSmoke

Job Done. Smoke Control

Integrated Fan and Damper Control

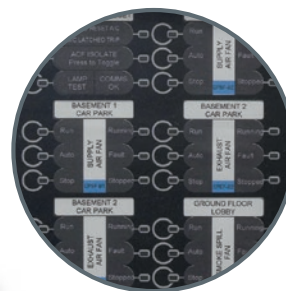

Advanced's Axis AX fire system features **DynamixSmoke**, dedicated and non-dedicated fan and damper control, for fire and life safety. As you'd expect from Advanced it's a high performance solution that is easy to configure and maintain, even on the most complicated sites.

Features

- Regulatory Compliance Assured
- Automatic and manual smoke control options in accordance with NFPA and National Building Code Standards
- Dedicated smoke control auto/manual controls and LED status indicators
- Customized FSCS firefighter smoke control (graphic) stations can be located locally or remotely
- Groundbreaking ease-of-use
- Simple 'spreadsheet-style' programming matrix is a step change that makes even the most complex smoke control programming easy
- System divided into virtual smoke control compartments in software for automatic fan and damper control (cbe)
- Uses standard I/O modules for fan and damper interfacing. Software auto-configures outputs for Run/Stop and Open/Close, with feedback inputs if required
- All options configurable from one dedicated menu with the Config Tool
- Interlocking feature to prevent over pressurization of ducts
- Post fire purge options with configurable priorities
- Auto stairwell pressurization option
- Key switch enable/disable option
- Manual controls can be configured for one-to-one operation, or grouped one-to-multiple fans or dampers
- Duct probe option – will override auto settings if smoke detected
- The system can respond only to the first smoke compartment in alarm or priorities can be set so that devices respond dynamically to a spreading fire
- Dedicated smoke control reset function
- All Manual controls take priority over Automatic mode
- Adjustable feedback delay ensures fans are given time to run or a damper is allowed time to travel before any trouble conditions reported
- Fully programmable sequential fan restart to avoid power spikes
- Automatic testing of fans and dampers including scheduled 'holiday' dates
- Engineering Test Menu allows HVAC to be controlled using panel menu and provides current operation and status feedback
- Customizable intelligent graphic annunciators with simple connection and configuration via panel P-BUS/PENN



Simple Smoke Control
Programming Matrix

PerfectSync

Fire Audio Perfected



PerfectSync delivers best-in-class synchronization of audio and strobes for fire, life safety and mass notification applications. PerfectSync achieves a level of integrity and performance not seen before.

Features

- Synchronization of audio and strobes across entire Axis AX network
- Dynamically adjusts as conditions change
- Prevents confusion during an emergency
- Aids in meeting intelligibility requirements
- No need for special programming or wiring
- Axis AX network capacity
 - 200 panels
 - 3200 distributed amplifiers
 - Each amplifier contains its own digital message generator
 - Each message generator can support 16 messages
 - 800 built-in NAC circuits
- Total synchronization

All speakers turn on and are fully synchronized even if the same message is played from different amplifiers connected to different panels on a large network. The maximum time to re-activate any speaker output following the first message played does not exceed 5 seconds.

When a fire spreads, any new affected areas or higher priority messages will begin immediately. This may result in some areas of the building being briefly out of sync. With PerfectSync these areas will quickly re-synchronize again even on a large network system. Similarly Paging operation may result in some areas of the building being temporarily out of sync as any automatic message must recommence from the beginning. With PerfectSync these areas will quickly re-synchronize.

- **More audio flexibility**

Up to 16 digital pre-recorded messages per amplifier. Simple 3-channel audio (Evac, Alert, Page) to complex multi-channel Mass Notification including individual message prioritization.

Unique audio engineering test feature confirms which amps are active, what message is playing, and can select and play a message in a specific area.

Command center audio control lockout with indication of who's 'in control'.



Advanced360*

Our Legendary Customer Support. In Person and Online.

Advanced360 offers total customer care from a staff of industry experts and engineers.

Support can cover help specifying a system or during installation or maintenance. Advanced360 also delivers full, free-of-charge installer training, online and telephone support and system and fault modeling services. It's Advanced, end-to-end fire system support, free to all customers.

New Lifetime Support Portals

Advanced360 now offers our customers personalized support via online portals. Services include (dependent on country):

- **Training**
View and book training slots.
Download your certificates at any time.
- **Software**
Download software and save software packages by installation/site.
- **Literature**
Manuals, specifications, technical information etc., all available for download.
- **Product Demos**
Book a sales call or demo and request brochures, literature and technical information.
- **Approved Partner / Authorized Distributor Certificates**
Available for order and download.

Sign up now at 360.advancedco.com

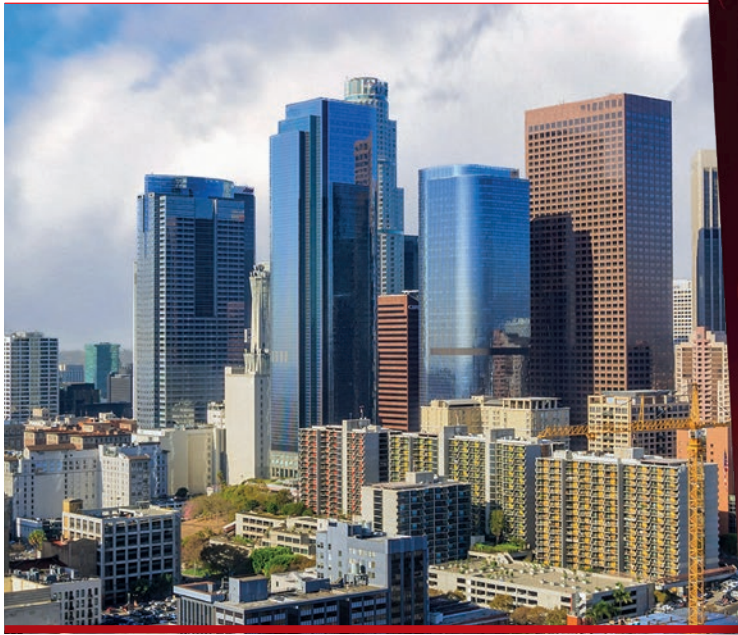

Fire and Emergency Telephone System

Exceptional Clarity for Superior Performance



Providing robust telephone communication channels ensures maximum safety.

The Advanced Fire and Emergency Telephone System provides:

- **Addressability** – for precise identification of the location of field telephone users.
- **Flexibility** – so it can be configured as a standalone, independent system or completely integrated into the fire system.
- Crystal clear live voice channels with no delays or echoing and a background noise cancellation option.
- Reassurance of communication channel status via dial, ring, busy and hold tones, as well as local LED indication at each addressable handset.

We've even made it quicker and easier to install and configure.

Ideal for installations where local fire departments and emergency/facility personnel need access to fire/emergency telephone communications, e.g. in high and low-rise apartment buildings, hotels, universities, government and military sites.

As an entire telephone system can be installed and configured to operate standalone without panels, Advanced fire and emergency phones are also perfectly suited to any retrofit or non-fire application.

Visit www.advancedco.com to download our Fire and Emergency Telephone System brochure



A Global Leader

The quality, performance and ease-of-use of Advanced's fire systems means we are a supplier of choice to fire and facilities professionals globally.

Our systems hold global approvals and can scale from single panel, single loop to huge, multi-loop, high-speed networks covering vast areas.

We are specified and installed in some of the most prestigious and challenging locations in over 60 countries worldwide.



Find out more and watch our corporate video at advancedco.com

Advanced's 520 Hz sounder base

Designed for easy replacement of the CO sensor module

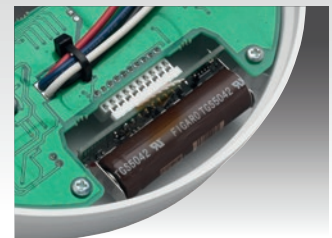
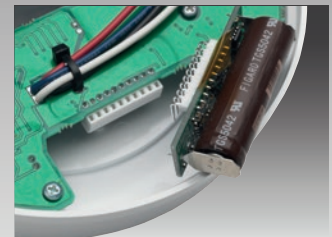
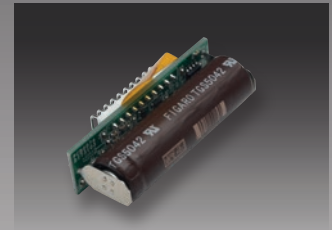
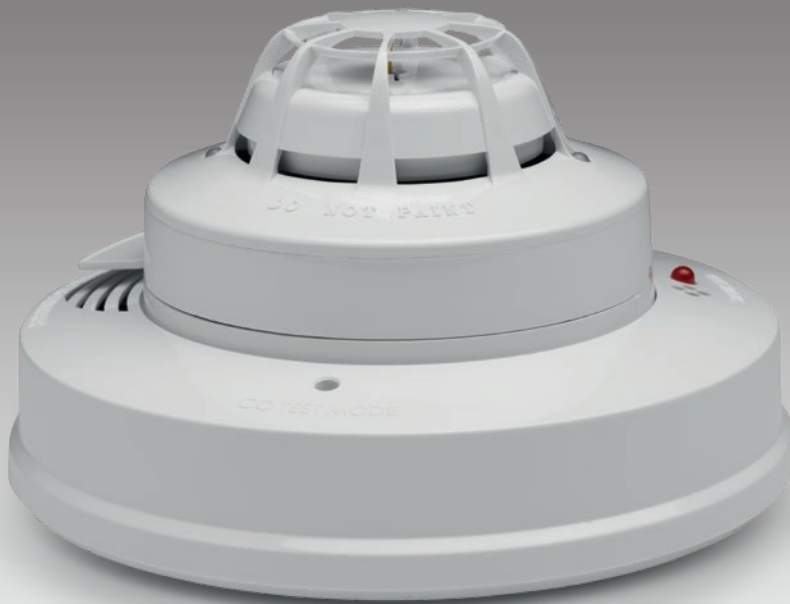

Our carbon monoxide detector and low frequency 520 Hz sounder base is simple to install and has the huge advantage of a replaceable CO sensor module, saving significant labor time and cost.

No need to replace the entire device when the CO sensor expires. Simply replace the sensor module without removing the base from the wall or ceiling, and run a quick test. It's as easy as that.

- UL and ULC approved
- Automatic and manual CO sensor testing
- Replaceable CO sensor module
- Use the base with an Advanced intelligent smoke, heat or multi-sensor detector, or with a low profile blank cover if carbon monoxide detection only required
- Three CO detection levels
- Sounder output may be powered by 24 Vdc or NAC circuits
- Separate control of 520 Hz sounder

www.advancedco.com

 **Advanced**
The Standard in Fire Systems



US HQ

100 South Street, Hopkinton, Massachusetts 01748 USA
Tel: (508) 435-9995 **Fax:** (508) 435-9990

25 Corporate Drive, Auburn Hills, Michigan 48326 USA
Tel: (248) 332-3900 **Fax:** (248) 332-8807

Global headquarters in Newcastle upon Tyne, UK

Offices in: London and Barnsley, UK

Dubai, UAE

Belgrade, Serbia

Bangalore and Delhi, India

Ho Chi Minh City, Vietnam

Email: ordersusa@advancedco.com

Web: www.advancedco.com



@advancedlive



Advanced – The Standard in Fire Systems

Find us on NBS National BIM Library

A **Halma** company