

ATTOM

Micro Data Center Solution



Foundation of Digital Future

Simplifying and protecting your digital system with this pre-manufactured, self-contained and readily scalable micro data center solution.



Customize with Expert

The Edge Wave

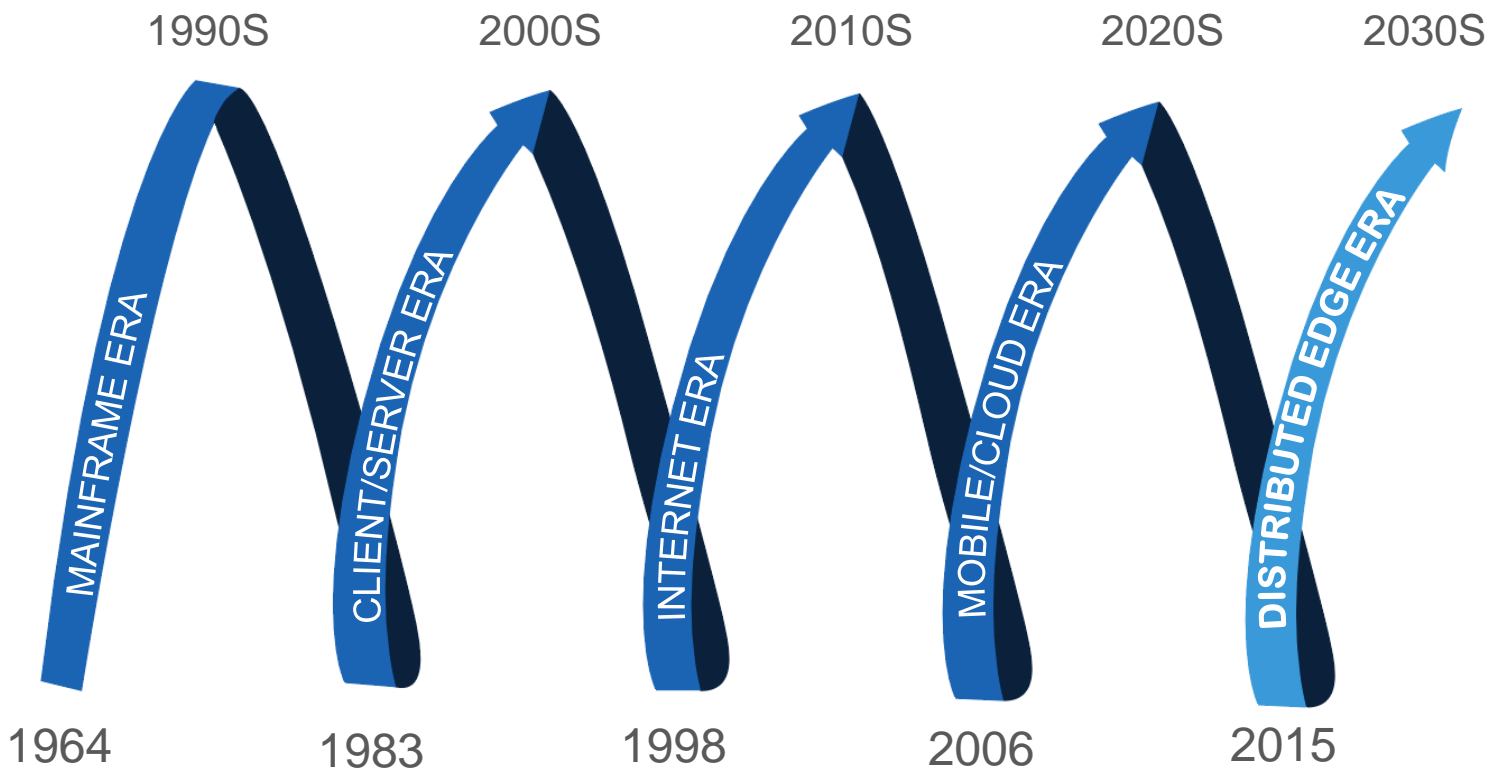

>> Are you ready to catch the coming edge era wave?

Micro Data Center for Edge Computing

Edge Data Center plays key roles in the next wave of edge computing development, with the functions of reducing latency, improving safety, and saving network cost.

Edge Data Center is suitable for diverse applications and sites from enterprise, telecom, to edge colocation industries.

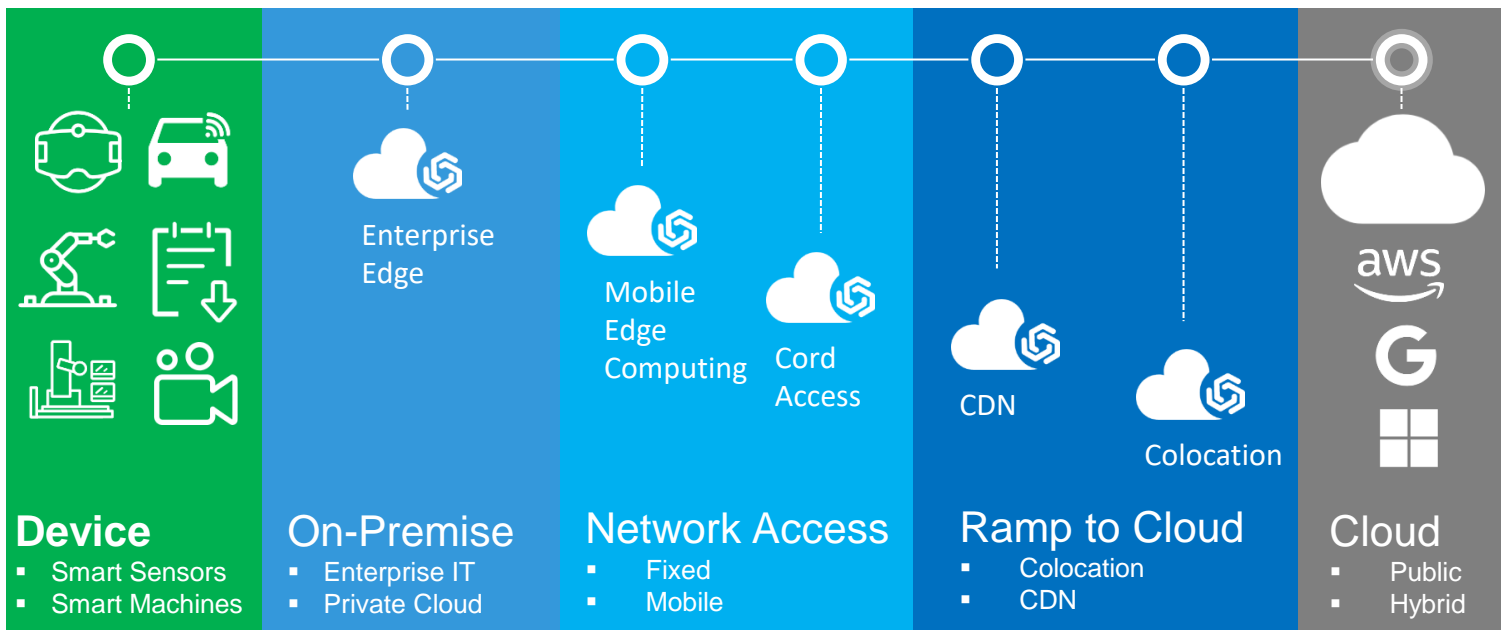

Micro Data Center Applications

IIoT & Edge Computing

Private Cloud & Hybrid Cloud

AI & Deep Learning

SMB & Office



Telecom & ISP



Banks & Financial



Retail & Logistic



Smart Manufacturing



Military, Energy & Mining



Medical & Education



Customize with Expert



Attom Micro Data Center Platform



AgileRak™

Indoor Micro Data Center

Fully integrated with indoor type rack, UPS power, battery, cooling, monitoring, security, and fire systems.

Available from half rack to multiple racks. Customization is acceptable.



AgileHub™

Outdoor Micro Data Center

Fully integrated with outdoor type cabinet, UPS/DC power, battery, cooling, monitoring, security, and fire systems.

Available with 1 to 3 cabinets all in one solution. Customization is acceptable.



AgileCub™

Container Micro Data Center

Fully integrated with ISO container, cabinet, UPS/DC power, battery, cooling, monitoring, security, and fire systems.

Available with 10f, 20f and 40f all in one solution. Customization is acceptable.

Attom Micro Data Center Benefits

An easy flexible, expandable, intelligent micro data center product is one of the keys to the edge computing success.

With all these in mind , we create this Attom Micro Modular Data Center products platform.

It's a plug and play, totally enclosed and fully integrated solution built in with rack, power & battery, cooling, monitoring and security systems.

Easy Deployment

Pre-manufactured and fully tested means that no on-site engineering needed to activate the product. Within one day, you can deploy the IT equipments and quickly power on your business.

Easy Management

Design once and deploy anywhere. By this standardized architecture and remote monitoring access platform, you can gain control of these critical assets, reduce risks and operational costs, and improving service levels.

Easy Expansion

A stand alone full function solution. You can plan and invest your IT assets step by step while your business grows. Buy small and scale to big. Invest only when necessary.

Customize with Expert



AgileRak™ Series

MDC with Top Package Cooling

3k – 6k MDC fully integrated with closed rack, package cooling, UPS, battery, power distribution, security, monitoring and fire systems.

No complex piping of remote condenser installation.



MDC with Row Package Cooling

5k – 10k MDC fully integrated with closed rack, package cooling, UPS, battery, power distribution, security, monitoring and fire systems.

No complex piping of remote condenser installation.



MDC with Rack Split Cooling

3k – 10k MDC fully integrated with closed rack, split cooling, UPS, battery, power distribution, security, monitoring and fire systems.

Modular rack cooling flexible for rack oriented MDC plan, expansion and deployment.



MDC with Row Split Cooling

6k – 20k MDC fully integrated with closed rack, split cooling, UPS, battery, power distribution, security, monitoring and fire systems.

Row cooling seamless integration with rack row and capacity expansion.



Key Characteristics

- Rack-level cooling, cold and hot aisle isolation, high efficiency, the PUE values as low as 1.3
- Plug and play design, available online in 10 minutes at the fastest
- Fully enclosed design, dust and noise reduction, protection level up to IP55
- Cabinet covered with insulation material to prevent condensation
- The cabinet is equipped with an emergency pop-up door system as standard, which can automatically open the front and rear doors in the event of a high temperature or fire alarm
- Cabinets, power distribution and cooling units have a variety of forms and specifications for flexible application
- The front and rear doors of the cabinet are equipped with a 3-in-1 access control system
- Standard 10-inch integrated touch monitor screen, the monitoring system does not take up U space of the cabinet
- Support remote web, APP and centralized monitoring, support monitoring protocols such as Modbus-TCP, SNMPV1 / V2, BACnet
- Support global customized services

AgileRak™ Series



Customize with Expert



AgileRak™ Series

Technical Data – AgileRak Rack Type Micro Data Center

Model	ATM-03N	ATM-03W	ATM-06E	ATM-06T	ATM-06F	ATM-06K	ATM-10S	ATM-10G
Available Space	18U	19U	26U	29U	35U	35U	35U	35U
Redundancy	N	N	N	N	N	N	N	N
Width -mm	600/800	600	600	600	900	900	900	900
Depth -mm	1100	1100	1100	1100	1400	1400	1400	1400
Height -mm	1200	1590	2000	2000	2000	2000	2000	2000
Weight -kg	162	190	330	374	521	521	525	525
IP Level	IP5X	IP5X	IP5X	IP5X	IP5X	IP5X	IP5X	IP5X
Power Section								
UPS -kVA	3	3	6	6	6	6	10	10
Recommended power for IT -kW	< 2.0	< 2.4	< 3.2	< 3.5	< 5	< 5	< 7	< 7
UPS Type	Rack	Rack	Rack	Rack	Rack	Rack	Rack	Rack
Standard Battery	12V/9AH 6Pcs	12V/9AH 6Pcs	12V/9AH 16Pcs	12V/9AH 16Pcs	12V/9AH 16Pcs	12V/9AH 16Pcs	12V/9AH 16Pcs	12V/9AH 16Pcs
PDU	Basic 8Slots	Basic 8Slots	Basic 16Slots	Basic 16Slots	Basic 16Slots	Basic 16Slots	Basic 16Slots	Basic 16Slots
Recommended Breaker	16A	32A	63A	63A	63A	63A	80A	80A
Cooling Section								
Cooling Type	Fan Ventilation	Packaged DX	Packaged DX	Split DX	Split DX	Package DX	Split DX	Package DX
Mount Type	Top	Top	Top	Rack	Row	Row	Row	Row
Capacity-kW	2.0	3.5	3.5	3.9	5.6	5.6	7.6	7.6
Emergency Ventilation	√	√	√	√	√	√	√	√
Monitoring Section								
	Touch Screen, Remote Web Access	Touch Screen, Remote Web Access	Touch Screen, Remote Web Access	Touch Screen, Remote Web Access	Touch Screen, Remote Web Access	Touch Screen, Remote Web Access	Touch Screen, Remote Web Access	Touch Screen, Remote Web Access
	Temp. & Hum.	Temp. & Hum.	Temp. & Hum.	Temp. & Hum.	Temp. & Hum.	Temp. & Hum.	Temp. & Hum.	Temp. & Hum.
	UPS Mgmt.	UPS Mgmt.	UPS Mgmt.	UPS Mgmt.	UPS Mgmt.	UPS Mgmt.	UPS Mgmt.	UPS Mgmt.
Monitoring Function	-	Cooling Mgmt.	Cooling Mgmt.	Cooling Mgmt.	Cooling Mgmt.	Cooling Mgmt.	Cooling Mgmt.	Cooling Mgmt.
	Fire Detection	Fire Detection	Fire Detection	Fire Detection	Fire Detection	Fire Detection	Fire Detection	Fire Detection
	-	Water Leaking	Water Leaking	Water Leaking	Water Leaking	Water Leaking	Water Leaking	Water Leaking
	Door Status	Door Status	Door Status	Door Status	Door Status	Door Status	Door Status	Door Status

AgileRow™ Series

Closed Aisle System

Independent cold / hot closed aisle are integrated at the front and rear of the cabinet, respectively.

Monitoring System

All in one monitoring host collects, displays and reports system status, locally and remotely.

Security System

3 in 1 access control system (Pin/Fingerprint/RFID) and video monitoring system.



Power Distribution

Rack mount power distribution, metering, and management for all the power lines.

Power System

48VDC power, or 3kVA – 200kVA rack mount or modular UPS system protect power continuity.

Cooling System

2.5kW – 90kW rack / row mount precision cooling, seamlessly matched to the rack.

Server Rack

Standard 19-inch server cabinet, glass front door, sheet metal back door

Customize with Expert



AgileRow™ Series

Technical Data - AgileRow Type Micro Data Center

Model	Customization
Maximum Rack No. -pcs	20 / Row
Power Density -kW/Rack	<20
Rack Depth -mm	1400 or customize
Rack Width -mm	600 / 800
Rack Height -mm	2000 / 2200 / 2500
Closed Aisle	Hot and cold aisles are fully closed or semi-closed
Power Section	
UPS -kVA	Up to 200kVA / unit
Battery	Per Situation, VRLA / Lithium-ion Battery
PDU	Basic / Smart
Cooling System	
DX Cooling -kW	Up to 90kW / unit
Cooling Type	DX / CW
Mount Type	Top / Row / Rack
Fire System	
Fire detection Sensor	Smoke / Temp / Early Detection
Fire Extinguishing Gas	FM200
Mount Type	Rack
Monitoring Section	
	Touch Screen, Remote Web Access
	Temp. & Hum.
	Power Mgmt.
Monitoring Function	Cooling Mgmt.
	Fire Detection
	Water Leaking
	Video Monitoring
	Access control

AgileCub™ Series

Attom container type Micro Data Center designed and engineered with standard container size of all in one design helps IT professionals deploy data center quickly and easily.

Fire System

Fire extinguisher and early detection system.

Cooling System

2.5kW – 40kW precision cooling in rack mount, top mount and row mount type.

Monitoring System

All in one monitoring host collects, displays and reports system status, locally and remotely.

Power Distribution

Rack mount power distribution, metering, and management for all the power lines.

UPS System

3kVA – 200kVA rack mount modular UPS system protect power continuity.

Security System

3 in 1 access control system(Pin/Fingerprint /RFID) and video monitoring system.

Battery System

Optional lead-acid batteries and lithium-ion batteries (Rack-mount)

Rack System

Standard 19-inch server cabinet, 75% front and rear mesh door through-hole ratio, static load up to 1800kg, various options available

Customize with Expert



AgileCub™ Series



10F Container Data Center

All in one 10F Container MDC fully integrated with standard rack, wall mount cooling, AC/DC power, battery, power distribution, security, monitoring and fire systems.

IP55 protection and thermal insulated for outdoor deployment.

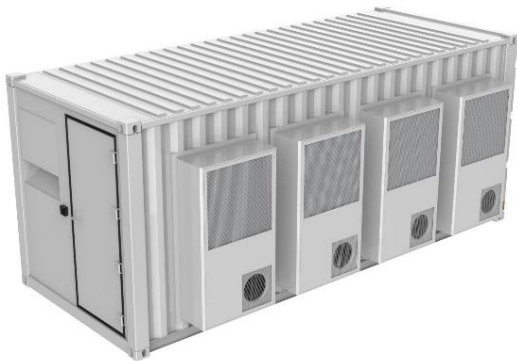

20F Container Data Center

All in one 20F Container MDC fully integrated with standard rack, wall mount cooling, AC/DC power, battery, power distribution, security, monitoring and fire systems.

IP55 protection and thermal insulated for outdoor deployment.

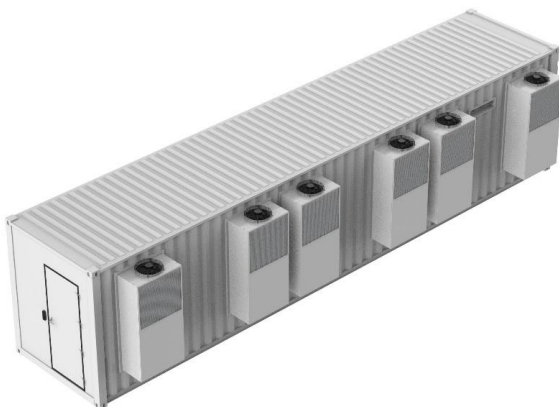

40F Container Data Center

All in one 40F Container MDC fully integrated with standard rack, wall mount cooling, AC/DC power, battery, power distribution, security, monitoring and fire systems.

IP55 protection and thermal insulated for global deployment.

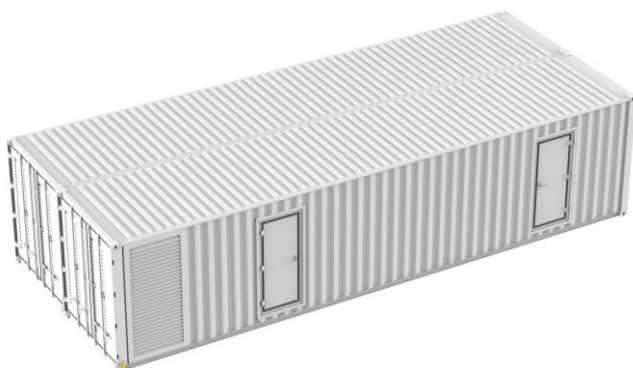

Dual Container Data Center

Assembled from 2 or more containers, integrated with standard rack, row mount cooling, AC/DC power, battery, power distribution, security, monitoring and fire systems.

IP55 protection and thermal insulated for global deployment.

AgileCub™ Series

Technical Data – AgileCub Containerized Micro Data Center

Model	ATM-10-C03	ATM-20-C03	ATM-30-C08	ATM-60-C08	ATM-80-C18	ATM-140-C18	ATM-160-C36	ATM-320-C36	Customization
IT Rack No.	2	2	6	6	16	14	32	30	Per Definition
Power Density - kW/Rack	5	10	5	10	5	10	5	10	<20
Container Width -mm	2438	2438	2438	2438	2438	2438	4876	4876	Per Definition
Container Length -mm	2991	2991	6058	6058	12192	12192	12192	12192	Per Definition
Container Height -mm	2896	2896	2896	2896	2896	2896	2896	2896	Per Definition
Power System									
Power Redundancy	N+1	N+1	N+1	N+1	N+1	N+1	N+1	N+1	N+1 / 2N
UPS Capacity -kVA	2* 10	3* 10	3* 15	5* 15	5* 25	7* 25	8* 25	7* 50	Max. 500kVA
UPS Type	Rack	Rack	Sub-Modular	Sub-Modular	Sub-Modular	Sub-Modular	Sub-Modular	Floor-Modular	Configure on demand
Battery	15min@10kW	15min@20kW	15min@30kW	15min@60kW	15min@80kW	15min@140kW	15min@160kW	15min@300kW	Configure on demand
PDU	Smart Type	Smart Type	Smart Type	Smart Type	Smart Type	Smart Type	Smart Type	Smart Type	Per Situation
Cooling System									
Cooling Redundancy	N+1	N+1	N+1	N+1	N+1	N+1	N+1	N+1	N+1 / 2N
Capacity -kW	2* 12.5	2* 21.2	3* 17.5	4* 21.2	5* 21.2	8* 21.2	10* 21.2	18* 21.2	Row /Room /Wall
Mount Type	Wall	Wall	Wall	Wall	Wall	Wall	Wall	Wall	Row /Room /Wall
Fire Extinguishing System									
Fire Warning System	VESDA /Smoke/Temp	VESDA /Smoke/Temp	VESDA /Smoke/Temp	VESDA /Smoke/Temp	VESDA /Smoke/Temp	VESDA /Smoke/Temp	VESDA /Smoke/Temp	VESDA /Smoke/Temp	VESDA /Smoke /Temp
Fire Extinguishing Gas	FM200 / Novec1230	FM200 / Novec1230	FM200 / Novec1230	FM200 / Novec1230	FM200 / Novec1230	FM200 / Novec1230	FM200 / Novec1230	FM200 / Novec1230	FM200 / Novec1230
DCIM System									
	Touch Screen	Touch Screen	Touch Screen	Touch Screen	Touch Screen	Touch Screen	Touch Screen	Touch Screen	Touch Screen
	Temp. & Hum.	Temp. & Hum.	Temp. & Hum.	Temp. & Hum.	Temp. & Hum.	Temp. & Hum.	Temp. & Hum.	Temp. & Hum.	Temp. & Hum.
	Power Mgmt.	Power Mgmt.	Power Mgmt.	Power Mgmt.	Power Mgmt.	Power Mgmt.	Power Mgmt.	Power Mgmt.	Power Mgmt.
Monitoring Function	Cooling Mgmt.	Cooling Mgmt.	Cooling Mgmt.	Cooling Mgmt.	Cooling Mgmt.	Cooling Mgmt.	Cooling Mgmt.	Cooling Mgmt.	Cooling Mgmt.
	Fire Detection	Fire Detection	Fire Detection	Fire Detection	Fire Detection	Fire Detection	Fire Detection	Fire Detection	Fire Detection
	Water Leaking	Water Leaking	Water Leaking	Water Leaking	Water Leaking	Water Leaking	Water Leaking	Water Leaking	Water Leaking
	Video Monitoring	Video Monitoring	Video Monitoring	Video Monitoring	Video Monitoring	Video Monitoring	Video Monitoring	Video Monitoring	Video Monitoring

AgileHub™ Series

AgileHub Micro Data Center developed with multiple configurations that fit into diverse application scenario, all with prefabricated size supports predicted management and quick deployment.

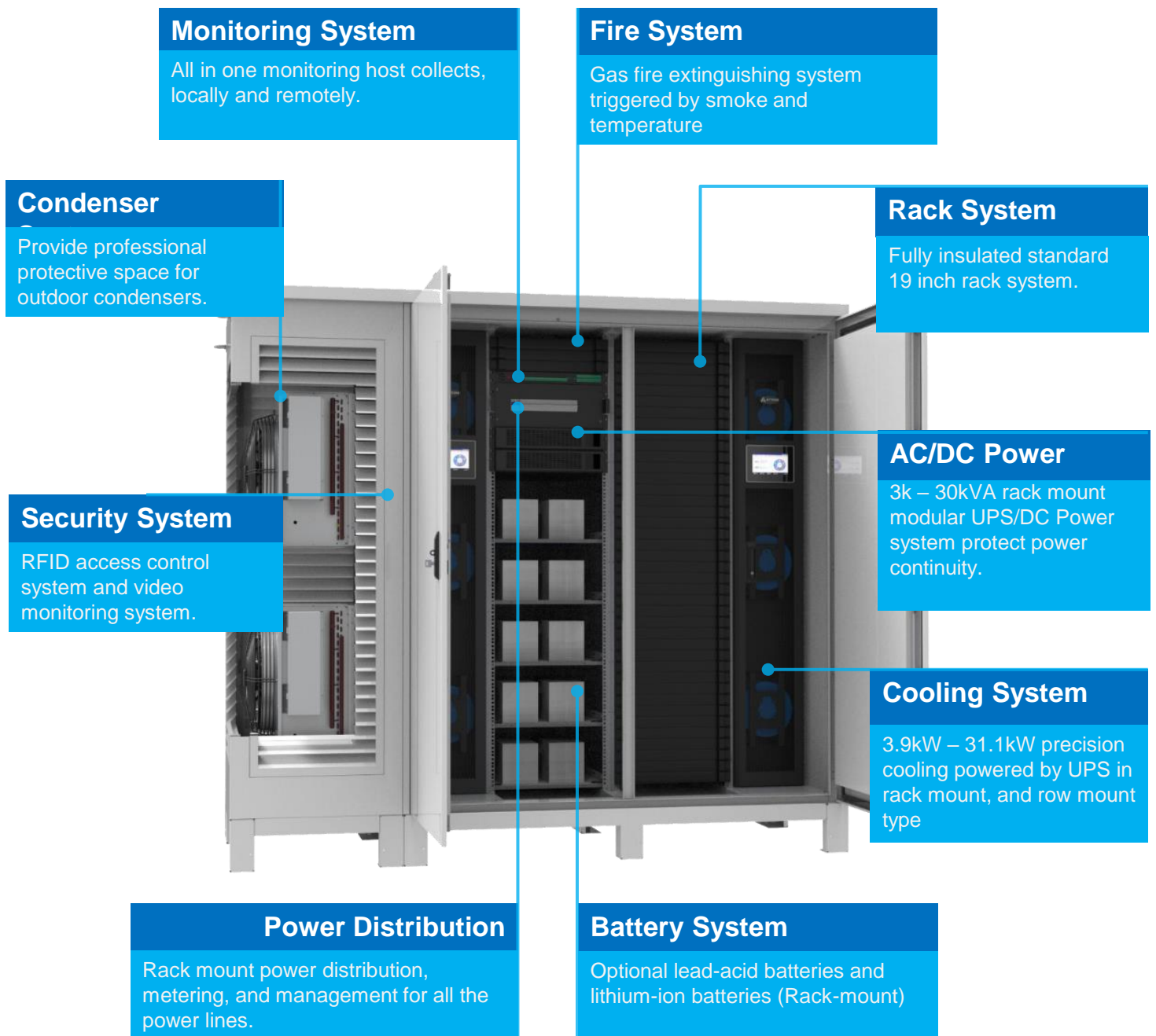

AgileHub™ Series



1-Rack MDC with Rack Cooling

MDC fully integrated with 1 rack space, rack cooling, AC/DC power, battery, power distribution, security, monitoring and fire systems.

IP55 protection and thermal insulated for outdoor deployment.



2-Rack MDC with Rack Cooling

MDC fully integrated with 2 rack space, rack cooling, AC/DC power, battery, power distribution, security, monitoring and fire systems.

IP55 protection and thermal insulated for outdoor deployment.



2-Rack MDC with Row Cooling

MDC fully integrated with 2 rack space, inrow cooling, AC/DC power, battery, power distribution, security, monitoring and fire systems.

IP55 protection and thermal insulated for outdoor deployment.



3-Rack MDC with Rack Cooling

MDC fully integrated with 3 rack space, rack cooling, AC/DC power, battery, power distribution, security, monitoring and fire systems.

IP55 protection and thermal insulated for outdoor deployment.

Customize with Expert



AgileHub™ Series

Technical Data – AgileHub Outdoor Micro Data Center

Model	ATM-03-H01W	ATM-06-H01K	ATM-10-H02K	ATM-10-H02R	ATM-20-H03K	Customization
Available IT Space	33U	27U	67U	73U	101U	Max 3 Rack
Redundancy	N	N	N	N	N	N /N+1 /2N
Width -mm	905	1400	2000	2600	2600	Per Situation
Depth -mm	1080	1600	1600	1600	1600	Per Situation
Height -mm	2105	2300	2300	2300	2300	2600 Max.
Cabinet Weight -kg	160	560	900	1160	1242	Per Situation
IP Level	IP55	IP55	IP55	IP55	IP55	Per Situation
Power Section						
UPS -kVA	Optional	6	10	10	20	Per Situation
Recommended IT Power -kW	1.5	≤3	≤5	≤5	≤10	Per Situation
UPS Type	Rack	Rack	Rack	Rack	Rack	Rack
Battery	Rack-mount Lithium (1* 48V50Ah)	Rack-mount VRLA (2* 16Pcs12V9Ah)	Rack-mount VRLA (2* 16Pcs12V9Ah)	Rack-mount VRLA (2* 16Pcs12V9Ah)	Rack-mount VRLA (32Pcs12V9Ah)	7-200Ah
Backup Time - min	60	20	13	13	5	Per Situation
PDU	BLVD: 8* 1P(MCB)	Basic 16Slots	Basic 16Slots	Basic 16Slots	Basic 16Slots	Basic/Smart
48VDC Power	2* 30A Modules	Optional	Optional	Optional	Optional	Per Situation
Cooling Section						
Cooling Type	Package DX	Split DX	Split DX	Split DX	Split DX	Packaged/Split
Mount Type	Door	Rack	Rack	Row	Rack	Door/Rack/Row
Capacity-kW	1.5	3.9	5	5.6	12	31 Max.
DCIM Section						
Monitoring Function	Remote Web	Remote Web	Remote Web	Remote Web	Remote Web	Remote Web
	Temp.&Hum.	Temp.&Hum.	Temp.&Hum.	Temp.&Hum.	Temp.&Hum.	Temp.&Hum.
	UPS Mgmt.	UPS Mgmt.	UPS Mgmt.	UPS Mgmt.	UPS Mgmt.	UPS Mgmt.
	Cooling Mgmt.	Cooling Mgmt.	Cooling Mgmt.	Cooling Mgmt.	Cooling Mgmt.	Cooling Mgmt.
	Smoke Sensor	Smoke Sensor	Smoke Sensor	Smoke Sensor	Smoke Sensor	Smoke Sensor
	Leaking Sensor	Leaking Sensor	Leaking Sensor	Leaking Sensor	Leaking Sensor	Leaking Sensor
	Door Status	Door Status	Door Status	Door Status	Door Status	Door Status

AgileMod™ Series

Monitoring System

Module-level monitoring system + local touch screen, supporting 3D, temperature cloud map and asset management, etc

Cabling System

Row-level cable ladder supports wiring between two columns of racks, and M-type cabling on the top of the rack supports isolated wiring

Closed Aisle System

It consists of horizontally expanding modular skylights, supports and doors, which can be opened automatically.

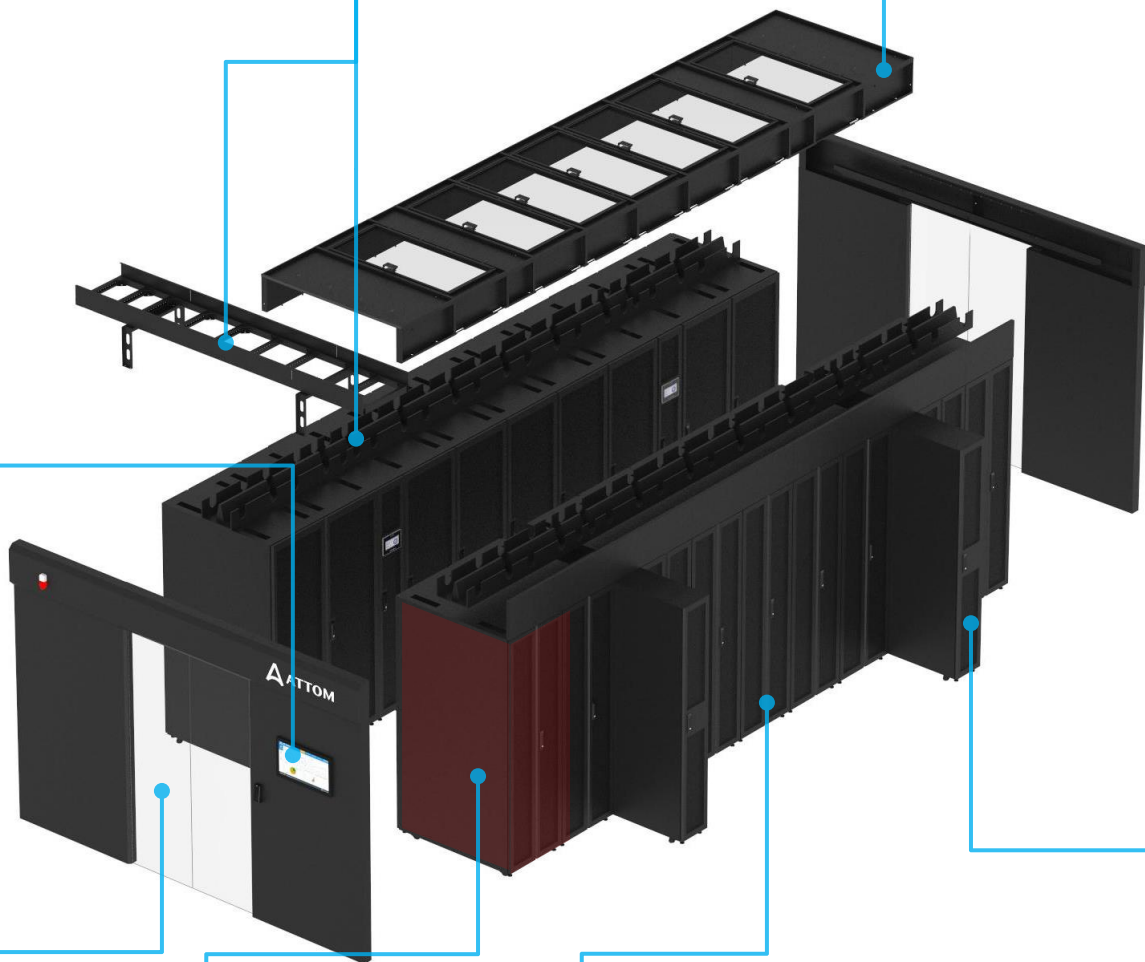

Access Door

All-glass door design electric sliding door assembly, support fingerprint + password + RFID access control

Power System

Integrated design of modular UPS and power distribution cabinet, Independent configuration is optional

Server Rack

Standard 19-inch server cabinet, 75% front and rear mesh door through-hole ratio, static load up to 1800kg

Cooling System

Row-mount Cooling system with DX or CW, the same appearance style as the server rack

Customize with Expert



AgileMod™ Series

Technical Data – AgileMod Containment Type Micro Data Center

Model	Customized
Maximum Rack No. -pcs	48 / Module
Power Density -kW/Rack	<20
Rack Depth -mm	1000 / 1100 / 1200
Rack Width -mm	600 / 800
Rack Height -mm	2000 / 2200 / 2500
Closed Aisle	Hot aisle closed / Cold aisle closed
Power Section	
UPS -kVA	Up to 500kVA / Unit
Battery	Per Situation, VRLA / Lithium-ion Battery
PDU	Basic / Smart
Cooling System	
Cooling -kW	Up to 200kW / Unit
Cooling Type	DX / CW
Mount Type	Row, Room
Fire System	
Fire type	No independent configuration, room-level fire system is recommended
Fire linkage	Automatically opens closed aisles and doors
Monitoring Section	
	Touch Screen, Remote Web Access
	Temp. & Hum.
	Power Mgmt.
Monitoring Function	Cooling Mgmt.
	Fire Detection
	Water Leaking
	Video Monitoring
	Access Control

Centralized Monitoring System

Centralized Monitoring system collects all the distributed Edge Micro Data Centers into a single console, to easily control, alert, and manage the remote sites, and simplify the multiple data center operation.

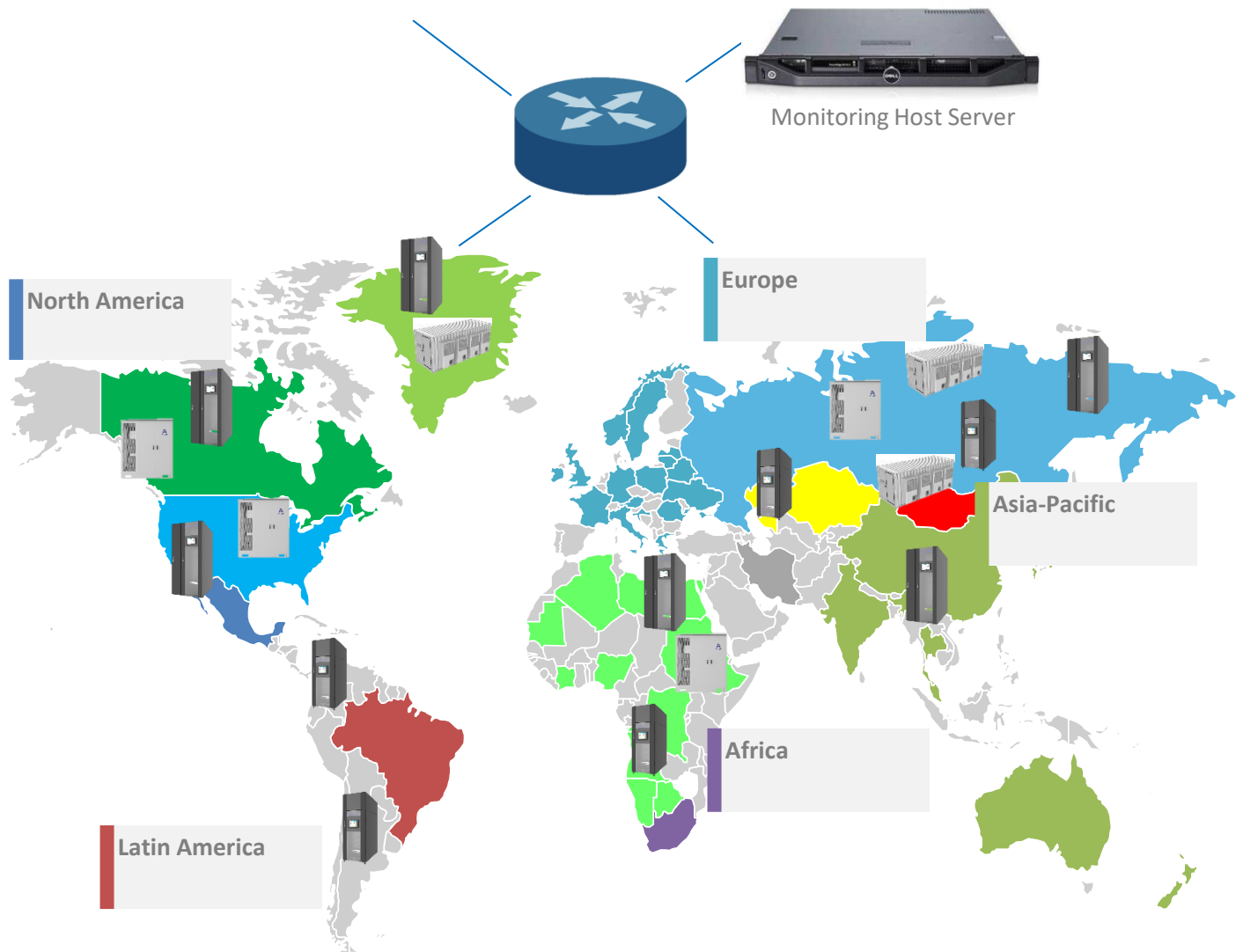

Customize with Expert



Why Work with Us

We Expertise Micro Data Centers



Expertise

Products designed with heart featuring reliable quality and balanced performance to protect your business revenue.

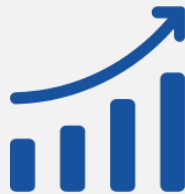

Speed

A professional team always standby with service spirit and quick response to support your business agility.



Flexibility

Fully customizable as per your requirements to build your own product solution and boost your own business.

Certifications



Customize with Expert

Our Customer Success

We always think in customer perspective to support our customers success. We build our long term success with the values of customer first.



Customize with Expert



Our Global Deployments

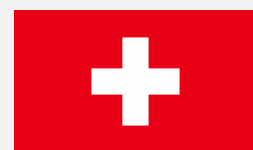
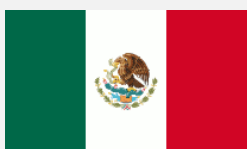

We believe the world is
being totally connected.
The connections are
creating digital intelligence
and a better future.

We create prefabricated
micro data center
products to build
foundation of digital
future.

Contact

Attom Technology

1450 NE Alex Way APT 299 Hillsboro, OR 97124, USA
06# Yangchong Road, Shenzhen, China

Call us
+1 301 6789 288

Email us
support@attom.tech

Visit us on web
<http://www.attom.tech>

